



日燭科技有限公司
JD Auspice Co., Ltd

DS3 series Switch-disconnectors 400, 350, 250A

DS3 series Switch-disconnectors

400, 350, 250A



1. Application

JDA-DS3 series switch-disconnectors is used in the power system with rated voltage up to DC1500V ,rated current up to 400A. It can be used for infrequent close and open, it provides isolation and breaking off circuit, it also provides safety isolation for any low voltage circuit of photovoltaic applications.

2. Product Pictures

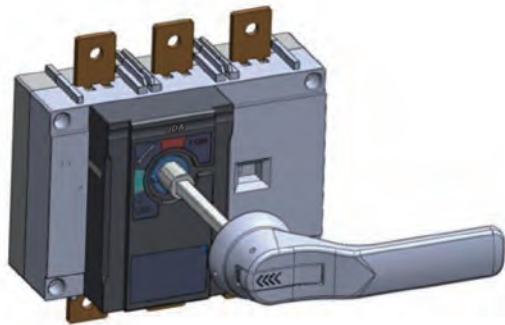

Three poles

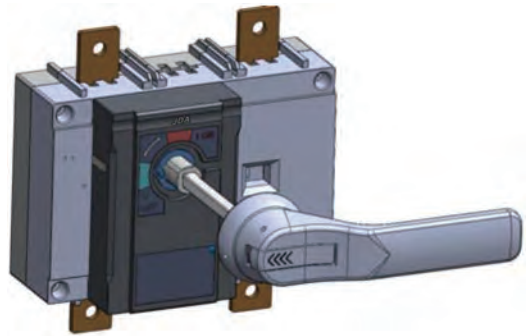

Two poles

3. Model and implication

3.1 JDA-DS3-400/350/250 product model implication



No.	Code	specification
1	Enterprise code	JDA brand
2	Product code	DS Switch-disconnectors
3	Design code	3
4	Rated current (A)	400、350、250
5	Number pf Poles	3 : Three poles 2 : Two poles
6	Current type	Z : DC photovoltaic product
7	Handle type	K : Inside-cabinet handle; P : Handle outside cabinet

3.2 Handle model implication



No.	Code	specification
1	Function code	Handle
2	Design code	1
3	Shaft code	200 : 200mm 400 : 400mm
4	Applicable switch model	DS3-800 : Apply to JDA DS3-250、350、400 , JDA DS3-500、630、800

3.3 Auxiliary contact model implication

A	1	-	□	□	/	DS3-800
1	2		3	4		5

No.	Code	specification
1	Function code	Auxiliary contact
2	Design code	1
3	Contacts number	11 : 1NO+1NC
4	Auxiliary switch mounting number	A:1 pc for each product B:2 pcs for each product
5	Applicable switch model	DS3-800 : Apply to JDA-DS3-400、350、250

3.4 Bridging links model implication

B	1	/	DS3-400
1	2		3

No.	Code	specification
1	Function code	Bridging links
2	Design code	1
3	Applicable switch model	DS3-400 : Apply to JDA-DS3-400、350、250

4. Main technical parameters

TUV and CE certification parameters are as follow diagram :

Parameter	Category/Unit	Specific parameter			
Rated Current In	A	400	350	250	
Thermal current Ith	A	400			
Number of Poles	Pole	2, 3			
Rated Insulation voltage Ui	V	DC1500			
Rated impulse withstand voltage Uimp	kV	12			
Rated operational current Ie (A)	DC21B	1000V	400/2	350/2	250/2
		1500V	400/3	350/3	250/3
Rated short-time withstand current Icw	kA 1s	DC : 10 kA			
Rated short-circuit making capability Icm	kA	DC : 17 kA			
Mechanical endurance	Cycles	5000			
Electrical endurance	Cycles	200			
Operation torque	N.m	18			
Tightening torque	N.m	14			

Connection capability	mm ² (Width×Thickness)	30 X 5*(2)	40 X 5*(2)	50 X 5*(2)
Installation method		M6 screw		
Weight(Kg)	3 Poles	4.8		
	2 Poles	4.4		

- Comply with standards:
- Approvals: TUV、CE。

5. Working conditions

- 1) Ambient temperature:-25 ~ +70°C,otherwise the customer should consult for manufacturer.
- 2) Altitude:≤2000m, otherwise the customer should consult for manufacturer.
- 3) Relative humidity: The relative humidity of the air does not exceed 50% at the maximum temperature of +40°C. The higher relative humidity may be permitted at lower temperature, e.g. 90% at +20°C, occasional condensation caused by the temperature change should be taken special measures.
- 4) Service place should be without explosive media, gas and dust which are corrosive and conductive, the product should be mounted free from rain and snow.
- 5) Pollution degree: 3.
- 6) Installation type: III and IV.
- 7) Protection degree: IP20; External handle: IP65.
- 8) Environmental protection requirements comply with RoHS directive.

6. Outline and installation dimensions

6.1 Screw mounting

Outline and installation dimension of two-pole product

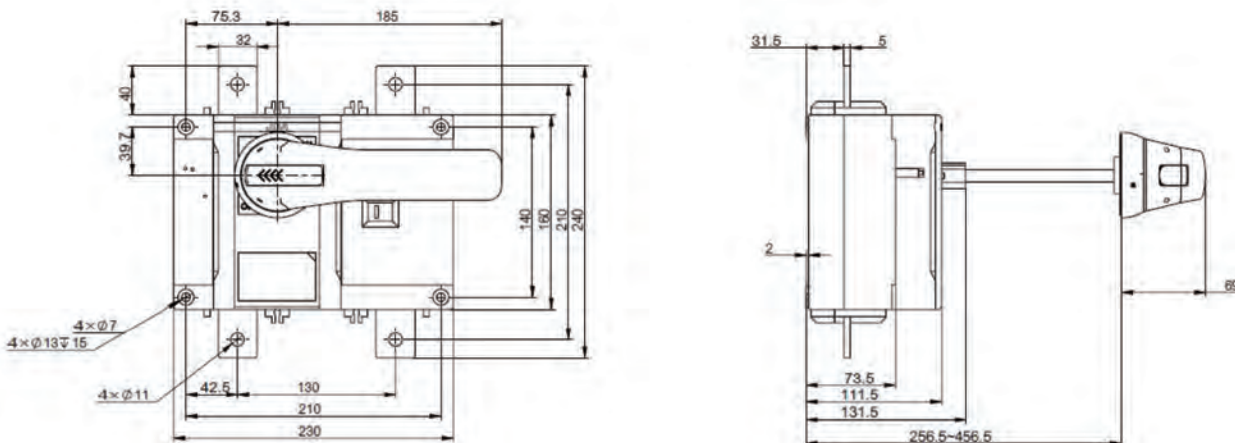

Outline and installation dimension of three-pole product

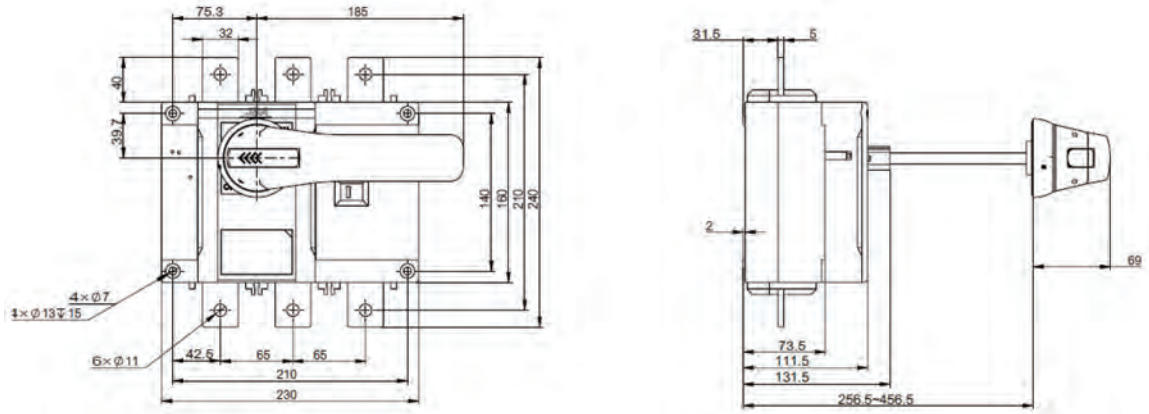

6.2 Dimension of panel drilling

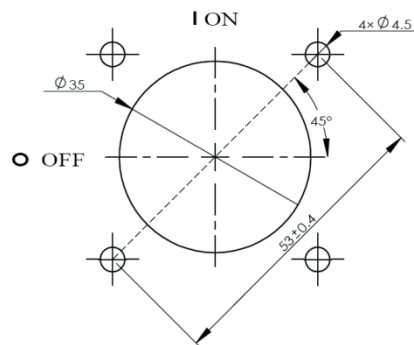

7. Installation method

Installation method: screw for switch, panel drilling for handle;

Installation position: vertical installation or horizontal installation. AS the 4th follow diagram show, when vertical installation, inspection window of the contact should not be upward. As the 5th diagram show, the product should be mounted within 5° of the vertical mounting plane in case the characters of the product are affected;

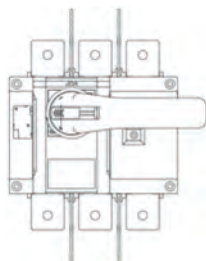

fig 1

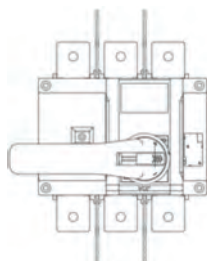

fig 2

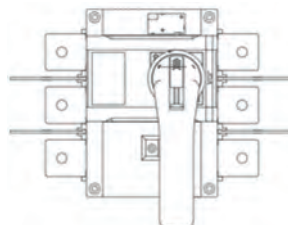

fig 3

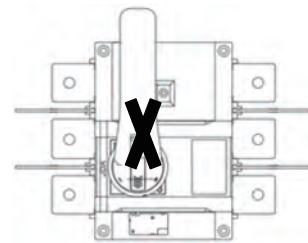

fig 4

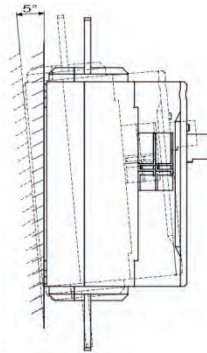
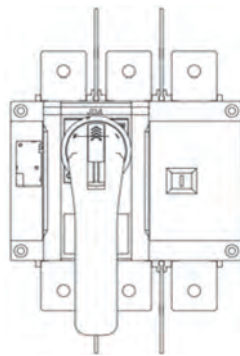

fig 5

The product should be mounted within 5° of the vertical mounting plane in case the characters of the product are affected

Status position : as follow diagram show, there are two position, switch on position “I/ON” and switch off position “O/OFF” .



Switch on

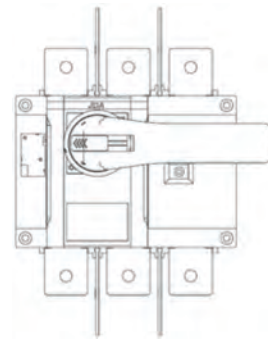

Switch off

8. Packaging and storage

8.1 Switch product packaging

No.	Model	Poles	Pcs
1	DS3-250 DS3-350 DS3-400	2P/3P	1pc/box

8.2 Accessories packaging (Maximum packing capacity)

Name	Number
Handle	2 pcs /box, 12 boxes/carton
Auxiliary contact	16 pcs/box, 40 boxes/carton
Bridging links	2 pcs/box, 4 boxes/carton

8.3 Storage

The product should be transited and deposited free from rain and snow. The product should be stored in the warehouse where there is ventilation. The relative humidity there should not exceed 80% (20±5°C) , and the ambient temperature there is between -40°C and +85°C. In addition, there should not be acidic, alkaline and corrosive gas in the air. The product should not be deposited more than 3 years in the above mentioned conditions since the producing date.

9. Accessory list and installation

9.1 Accessory list

No.	Name	Accessories installation and number	Remarks
1	Handle	fitted on the panel, connected to the switch through shaft	
2	Auxiliary contacts	fitted on the frontal left side of switch, up to 2pcs	
3	Bridging links	fitted on the contacts of switch, to make the connection of poles in series	

Circuit diagram of 3 poles connection in series

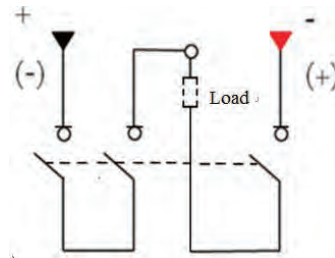

Circuit diagram of 2 poles connection in series

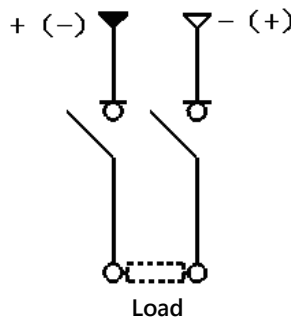

10. Notices

- 1) Manufacturer will take no responsibility for problems caused by disassembly .
- 2) Attention to live parts when the breaker is energized and avoid touching .
- 3) Please make sure reliable connection to avoid damage of terminal caused by exceptional heat resulting from unsuitable connection.